

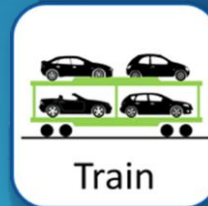

Operations Quality Manual



Version 7
January 2017



Established in 1997, ECG is the Association of European Vehicle Logistics and represents around 100 leading vehicle logistics companies from 28 countries across Europe, including Georgia, the Russian Federation, Ukraine and Turkey. ECG Members provide transport, distribution, storage, preparation and post-production services to manufacturers, importers, car rental companies and vehicle leasing operators. ECG's Brussels based secretariat works daily to fulfil the core mission of the Association, i.e. Information & Awareness; Education; Networking & Integration; Lobbying & Representation; and Standardisation. For more information, please visit the ECG website: www.ecgassociation.eu.

This OQM is supported by the following OEMs:

When using the ECG Operations Quality Manual or any other ECG publication (hereinafter the "Publications"), ECG accepts no responsibility for the Publications or for any loss or damage that may arise from your use of the Publications. The Publications are provided "as is" without warranties, conditions, representations or guarantees of any kind, either expressed, implied, statutory or otherwise, including but not limited to, any implied warranties or conditions of satisfactory quality, title, non-infringement or fitness for a particular purpose. ECG gives no guarantee that the Publications are free from errors or mistakes. No oral or written information or advice given by an ECG authorised representative shall create a warranty.

The user of the Publications is solely responsible for evaluating the integrity of the Publications as well as the accuracy and completeness of any information or guidelines contained therein, and the value and authenticity of the Publications.

ECG accepts no liability – in contract or otherwise – for any losses or damages with respect to any (use) of the information and guidelines included in or provided by the Publications.

This manual is primarily intended to help achieve the highest quality in handling of finished vehicles throughout the industry. Although safety issues are sometimes relevant to this, they are often covered by national legislation and then differ by country. Consequently, this manual may sometimes refer to best practice but in general it avoids making specific reference to safety issues and requirements as responsibility for this lies with the operators.

NEW

Table of contents

Introduction	6
1. General instructions.....	7
1.1. Clothing	7
1.2. Handling.....	7
1.2.1. Driving manner.....	7
1.2.2. Use of the vehicle.....	8
1.2.3. Rules to be respected when leaving the vehicle.....	8
1.2.4. Rules on non-starters	9
1.3. Inspections.....	9
1.4. Exceptional damage reporting	10
2. Road Transport.....	11
2.1. Equipment	11
2.1.1. Transporters.....	11
2.1.2. Transporter equipment.....	11
2.2. Loading/Unloading	11
2.2.1. Before loading or unloading	12
2.2.2. During loading or unloading.....	12
2.2.3. After loading or unloading	13
2.3. Lashing.....	13
2.3.1. Securing of vehicles loaded in the direction of the traffic.....	14
2.3.2. Securing of vehicles loaded in the direction opposite to the traffic.....	14
2.3.3. Additional securing of vehicles loaded rearmost in an angled position	14
2.3.4. Securing vehicles on the top deck.....	15
3. Rail transport.....	16
3.1. Equipment	16
3.1.1. Wagons	16
3.1.2. Wagon equipment	16
3.2. Loading/Unloading	16
3.2.1. Before loading or unloading	16
3.2.2. During loading or unloading.....	17
3.2.3. After loading or unloading	19
3.3. Lashing.....	19
4. Water Transport.....	20
4.1. Purpose-built sea-going car-carrying vessels	20
4.1.1. Equipment.....	20
4.1.2. Loading/Unloading	21
4.1.3. Lashing	24
4.2. Special provisions on Lo-Lo and Ro-Lo vessels designed for car transport.....	27
4.3. Special provisions on transport in containers.....	27
4.4. Specially designed Ro-Ro river barges.....	28
4.4.1. Barges.....	28
4.4.2. Loading/Unloading.....	28
5. Compounds	31
5.1. Technical requirements	31
5.1.1. Yard design.....	31
5.1.2. Yard equipment.....	31
5.1.3. Safety measures	32

5.1.4. Yard lighting	32
5.2. Storage.....	33
5.2.1. General storage rules	33
5.2.2. Parking	33
5.3. Maintenance and workshop / PDI centres.....	35
5.4. Compound auditing.....	36
5.5. Training.....	36
6. Handling of Alternative Fuel Vehicles (AFVs).....	37
6.1. General.....	37
6.2. In case of accident or fire.....	37
6.2.1. Electric & Hybrid Vehicles	37
6.2.2. Hydrogen Fuel Cell Vehicles + Compressed Natural Gas	38
6.3. Transport modes	38
6.3.1. Road transport	38
6.3.2. Rail transport.....	38
6.3.3. Maritime transport and port terminals	39
6.4. Compounds	39
6.5. PDI centres	40
6.6. State of Charge level and Hydrogen supply	40
6.7. Non-starters / Towing	40
6.8. Training	40

Introduction



This Operations Quality Manual is an ECG publication written in consultation and collaboration with the quality departments of many ECG members, OEMs as well as insurance and inspection companies.

The idea of establishing common quality standards for the whole industry was born from a commitment shared by the logistics service providers and the manufacturers to improve operational efficiencies by reducing duplication of activities due to the lack of harmonisation. Indeed, the standardisation of practices will also lead to a reduction in damage rates and a more rapid and effective handling of vehicles.

This manual is intended to be used as a management/supervisory guide when training staff on handling procedures. This should ensure a consistent approach. However, each manufacturer retains the right to demand a different treatment for their cars. This is why the manual often makes reference to the manufacturer's individual requirements. Such particular conditions have to be clearly defined, understood and adhered to by both parties according to contract. Moreover, these guidelines do not in any way supersede regulations stipulated by various national authorities. Copies of this manual can be downloaded free of charge from www.ecgassociation.eu. While translations into other languages are available only the English version is official.

Your comments and inquiries about this manual or the future activity of the Quality Working Group are warmly welcome via the e-mail address info@ecgassociation.eu or the telephone number +32 2 706 82 80.

Key:

-  - additional content compared to the previous version of the Operation Quality Manual
-  - minor change or deletion compared to the previous version of the Operation Quality Manual

1. General instructions

1.1. Clothing

- Personnel must wear clean working clothes at all times (no oil/grease stains).
- Long sleeves and long trousers are obligatory. $\frac{3}{4}$ trousers covering the knees are allowed during hot months.
- No buttons, exposed zips or belt buckles.
- Wearing safety shoes is obligatory. The shoes/boots must prevent the wearer from slipping.
-  Raised metal eyelets are not permitted in order to prevent sill, alloy wheel and lower door edge paint chips and scratches.
- Rings and other jewellery are not permitted, unless properly covered.
- It is forbidden to carry in one's pockets sharp objects (pens, tools, etc...) that could accidentally damage the vehicles.
- Working gloves must be worn when working on the truck, the wagon, the ship or the compound. However, they must be removed before entering the vehicle.
- Wearing high visibility jackets or clothes with high visibility elements is highly recommended in compounds. The use of safety helmets is subject to local laws, regulations or guidelines.
- If safety helmets are used for operations, they must be removed before entering the car.

1.2. Handling

- Vehicles can only be driven by personnel with a valid driving license that have received introductory training in the rules in this manual. The validity of the driving licenses has to be checked regularly, at least once a year.
- Vehicles can be driven only for the purpose of loading/unloading, parking and for working through the schedule of care measures.

1.2.1. Driving manner

- Vehicles must be driven at moderate speed in all situations. For an indication of the speed limit particular to a given transport mode, please refer to the corresponding section of this manual.

Vehicles must be driven in such a manner as to minimise the probability of damage. In particular, it is forbidden to:

- rev up the engine
- let the engine warm at idle speed
- set off rapidly with spinning drive wheels
- slip the clutch at high engine speeds
- drive on the starter motor

- overtake other vehicles
- drive with flat tyres
- have the accelerator pedal depressed prior to starting
- remove the ignition key whilst the vehicle is in motion
- drive with windows covered with snow or ice; Snow should be removed with a soft brush and ice should be removed only with plastic scrapers / environmentally friendly defroster spray without damaging the windows for the view in all directions to be clear and never by letting the engine run to warm the windows
- drive with open boot lid or doors.

Moreover, it is forbidden to use wipers on a windscreen covered with ice or snow. The driver/jockey must immediately stop the engine if an operational fault occurs or if a strange noise is detected.

1.2.2. Use of the vehicle

Vehicles and their equipment must be used only to such an extent and in such a manner that is necessary. The following are strictly forbidden:

- to lean, stand or sit on the vehicles
- to eat, drink or smoke in/near the vehicles
- to place objects on/in the vehicles
- to use any electronic equipment (audio, GPS, telephone, etc...), unless necessary for driving
- to manually move electric mirrors
- to open the roofs
- to write on vehicles
- to attach labels or stickers to vehicles, unless the manufacturer has explicitly authorised it and in clearly designated approved areas
- to remain in the vehicle longer than necessary
- to use a vehicle for towing or pushing another one
- to use vehicles as shuttles or for transporting material
- to detach/remove protection material (such as seat protection)
- to enter/exit the vehicle by other doors than the driver's
- to wear headphones or listen to music/radio
- to use cell phones and transmitters while handling/driving cars.

1.2.3. Rules to be respected when leaving the vehicle

Upon leaving the vehicle for storage/transport, it has to be checked whether:

- the doors, windows, roof, boot lid and bonnet are closed
- vehicles with manual transmission are engaged in 1st gear and have the hand brake (or parking brake) applied (for storage, hand brake must be released if possible)

- vehicles with automatic transmission have the transmission selector lever in “P” position and have the hand brake (parking brake) applied (for storage, handbrake must be released)
- all electronic equipment is left in the “off” position
- all storage compartments are closed to avoid any power drain on the battery during storage
- the vehicle is not parked on inflammable materials, such as dry grass or leaves
- the seat covers are in a proper position
- the driver seat is pushed back
- the door and carpet protectors (if present) are in a proper position.

1.2.4. Rules on non-starters

- If the car doesn't start because the battery is flat, it must be jump started using an auxiliary battery, never another vehicle. Always connect the positive (+) pole first then the negative (-) or earth pole. After jump starting, disconnect the cables in reverse order. Push starting and tow starting are prohibited!
- Jump starting cables must be handled with caution to prevent damage to the vehicle.
- If the vehicle needs refuelling, add a sufficient amount of the correct fuel type (unleaded petrol for petrol engines, diesel fuel for diesel engines). **Plastic or protected funnels and fuel can nozzles must be used in order to minimise the risk of both static flash ignition and damage.**
- If the two previous methods fail, contact the manufacturer of the car.
- A vehicle must never be jumpstarted / refuelled by anybody who has not received a relevant training. Whenever possible, non-starters should be handled by specialised personnel and not drivers.
- It is recommended to replace a flat battery by a new one before loading the vehicle on to transport (road transporter, rail wagon, ship or barge). However, this rule must be clearly stated and agreed to by the parties concerned by means of a written contract.

AMENDED

1.3. Inspections

- A thorough inspection of the vehicle has to be performed at each handling point.
- The vehicles must be inspected in the actual condition as they are delivered. It is not permitted for vehicles to be washed or for follow-up treatment to be given before the inspection is carried out.
- In case damage or theft is detected, a damage report must be directly filled in and signed by both the receiving and the transferring party.
- Damage and loss have to be claimed immediately and in any case before any car from the load has been moved and before the departure of the transporter.
- Inspection for damage is to be carried out in daylight or suitable artificial light. If night-time delivery occurs, the inspection must be carried out the next morning before 12 o'clock.
- If the circumstances render the inspection difficult (dirt, snow, etc.), it has to be noted on the inspection documents.
- Hidden damage can normally be claimed by the receiving party after the inspection.

1.4. Exceptional damage reporting

The central customer must be informed of damages incurred as a result of serious force majeure incidents as soon as they are detected.

2. Road Transport

2.1. Equipment

2.1.1. Transporters

- Only purpose-built car transporters may be used for transporting cars; they must be in good condition, painted and rust-free.
- The hydraulic systems must be functioning properly and not leaking.
- The transporters should be equipped with stone guards above the wheels.
- The surface of the decks and ramps must offer good grip without sharp edges.
- Loading ramps must be placed at a sufficiently low angle to enable easy access and prevent damage to the underbody of the transported vehicles. The recommended maximum ramp angle is 8 degrees.
- The upper deck of a car transporter must be equipped with safety ropes in conformity with the local legal requirements.
- The transporters must also respect all other local health and safety requirements.
- The loading deck pillars, the ropes and the supports of the safety ropes should be cushioned to secure damage free opening of the vehicle doors.
- The manufacturer may require inspection of new transporters and/or transporter types before approving them as suitable for the transport of their cars. The details of any such requirement must be clearly stated in the contractual agreement.

2.1.2. Transporter equipment

Car transporters must be equipped with:

- two sets of ramps of approximately 50-100 cm
- 3-4 chocks per transported vehicle
- 1-2 lashing straps per transported vehicle. Lashing straps must be 2.2 m long and stretch maximally by 4%. Moreover, they must be equipped with movable ("sock" type) strap control and meet the norm DIN EN 12195-2. The label on the lashing must not be washed out to a point when it becomes impossible to read (the norm must be clearly visible).

2.2. Loading/Unloading

- The rules that follow are specific to the loading/unloading process. Even so, the rules on car handling listed in the general section (Section 1.2.) also apply. Personnel must also be trained on these instructions before being allowed to proceed with loading, unloading or other handling.
- When loading, adapt the loaded weight, height and length to the national requirements and to the chosen routes.

2.2.1. Before loading or unloading

- The transporter must be parked on level and firm ground.
- The loading decks must be clear of all lashings, chocks, tools or other objects. It is forbidden to have lashings hanging on the anti-fall guard (safety ropes).
- The decks of the truck and the trailer must be fixed in a suitable position for loading vehicles without causing damage to their underbody.
- All gaps in the decks (wheel indents) must be covered with track sections. The decks of the truck and the trailer must be bridged with connecting ramps.

2.2.2. During loading or unloading

- Cars must be driven onto/from the transporters at walking speed to reduce the probability of causing damage. Speed must be particularly reduced before driving onto or off the ramps.
- Cars must be unloaded only under motor power. It is strictly forbidden to push the vehicles off the transporter, to brake with the hand brake or the clutch!
- It must be checked that the following distances are kept (to be measured with one's hand):
 - Between the cars, bumper to bumper: a fist (approximately 10 cm)
 - Between the car's roof and the upper deck: a fist (approximately 10 cm)
 - Between overlapping vehicles: a fist (approximately 10 cm)
 - Between a car on the truck and another on the trailer, bumper to bumper: 2 fists (approximately 20 cm)
 - Between the car's underbody and the deck: 3 fingers (5cm absolute minimum).

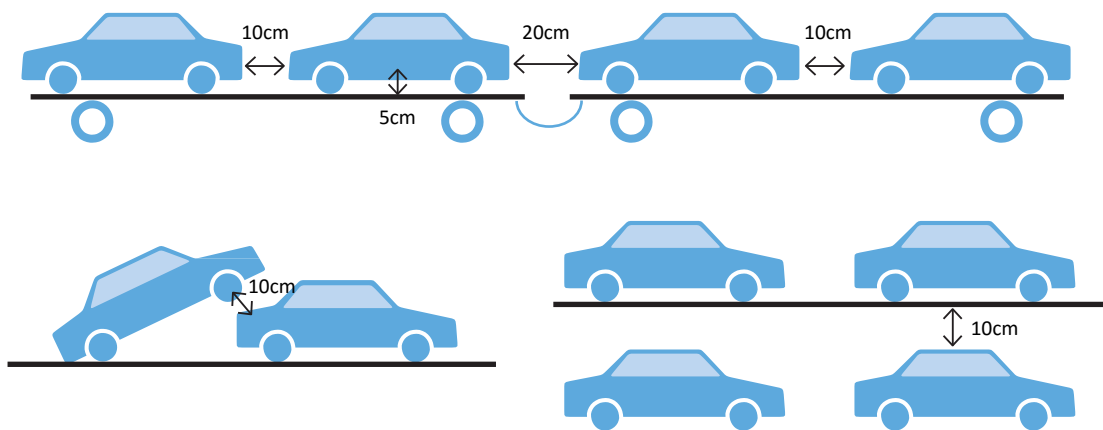

- The driver should always be able to ask for and obtain assistance during operations.

2.2.3. After loading or unloading

- Cars with manual transmission must be left in first gear and with the handbrake (parking brake) applied. Cars with automatic transmission must be left with the transmission selection lever in “P” position and the handbrake (parking brake) applied.
- If the cars have been loaded/unloaded during the night or under any other conditions that demand the use of headlights, they have to be switched off immediately after loading/unloading.
- Cars must be locked during transport. Keys must be secured.
- Cars must be lashed for transport according to the lashing procedures in the next section.

2.3. Lashing

Introductory note: This manual endorses the VDA-VDI lashing standard, which is enforced by the police of the Federal Republic of Germany. Those wishing to cross German territory are obligated to follow it or face prosecution.

ECG recognises that other lashing standards are used in Europe with excellent results in terms of efficiency and security. For example, a very “intuitive” method established by CAT, GEFCO and STVA has now been used for many years in France and on some international routes without any particular security problems.

Three point lashing straps with a strap sleeve in combination with wheel chocks must be used. The use of wheel chocks is not necessary if wheels are secured in troughs or chamfers that are openings in the ramps/decks which serve for fixing the wheels. The wheel should enter into the trough by ca. 1/6 of its diameter.

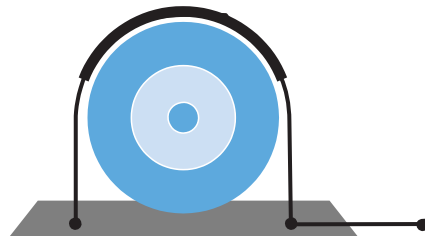

Lashing has to proceed as follows:

- Anchor the first hook to the transporter deck (lashing bar) in such a way that the strap runs as vertically as possible.
- Then tie the strap round the wheel, making sure that the strap sleeve is positioned correctly.

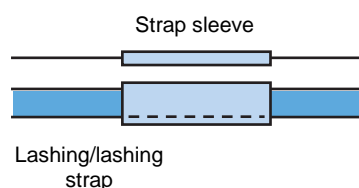
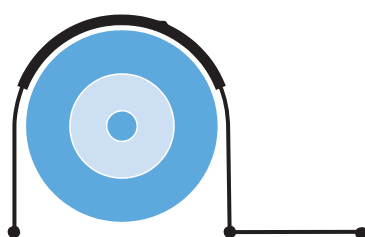

- Anchor the second hook to the transporter deck (lashing bar).
- Anchor the third hook at the anchor point lying laterally away from the wheel and tighten the strap using the ratchet.

2.3.1. Securing of vehicles loaded in the direction of the traffic

- One wheel chock in front and one behind either rear wheel.
- Additionally secure this rear wheel by means of a three point lashing.
- Diagonally from this wheel place one wheel chock in front of the respective front wheel.
- If wheel chocks cannot be used for technical reasons, an additional wheel must be secured with a lashing strap.

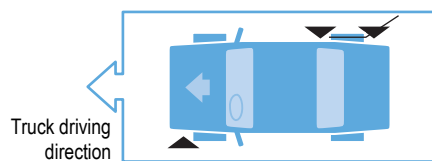

2.3.2. Securing of vehicles loaded in the direction opposite to the traffic

- One wheel chock in front and one behind either rear wheel.
- Diagonally to this wheel place one wheel chock in front of and one behind the respective front wheel.
- Additionally secure both wheels by means of one three point lashing each.
- If wheel chocks cannot be used for technical reasons, an additional wheel must be secured with a lashing strap.

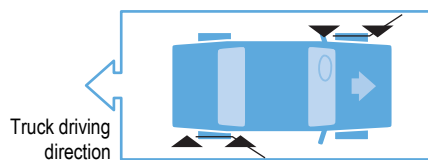

2.3.3. Additional securing of vehicles loaded rearmost in an angled position

The rearmost vehicle loaded behind the trailer's rear axle or, on a single car transporter, behind the rear axle of the truck, shall be additionally secured at the wheels of the rearmost axle by means of two wheel chocks and one lashing strap each.



NEW

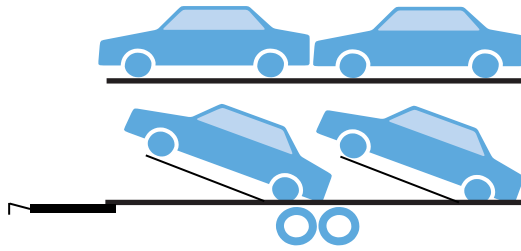

2.3.4. Securing vehicles on the top deck

In case a vehicle cannot be secured with wheel chocks or lashing belts within the protected area of the top deck, either one of the following must be done:

- The loading platform shall be lowered to allow performing of this work from the ground
- The wheels of one axle of the vehicle within the protected area shall be secured by means of two wheel chocks and one strap on each side

If wheel chocks cannot be used for technical reasons, an additional wheel must be secured with a lashing strap.

3. Rail transport

3.1. Equipment

3.1.1. Wagons

- Wagons should be in good condition, painted and rust-free. Moreover, they should be regularly cleaned, painted and repaired according to an established maintenance programme.
- The customer has the right to inspect all the wagons put to his disposition and refuse those that do not meet the quality criteria.
- Wagons must not have any structural damage, mechanical deck faults or obstacles on the decks that may hinder loading or unloading.
- Wagons should have protective material applied to surfaces that are more likely to come in contact with the vehicle, particularly its doors and bodywork.
- The profile of the deck must offer a good grip, but may not be sharp-edged.
- Loading ramps, whether fixed or mobile, must be placed at a sufficiently low angle to enable easy access and prevent damage to the underbody of the transported vehicles. The recommended maximum ramp angle is 8 degrees.

3.1.2. Wagon equipment

Each wagon should be equipped with a sufficient number of wheel chocks. As a general rule, there should be 4 wheel chocks per vehicle. However, on some routes and in some countries, vehicles can be fixed with two chocks on one wheel or a double chock, protecting the wheel from the front and from the back, on one wheel.

3.2. Loading/Unloading

The following rules are specific to the loading/unloading process. Even so, the rules on car handling listed in the general section (Section 1.2.) also apply. Personnel must also be trained on these instructions before being allowed to proceed with loading, unloading or other handling.

3.2.1. Before loading or unloading

- Wagons should be presented at the loading platforms in the right direction, so as to allow loading and unloading forwards. Reversing vehicles onto the wagons should be absolutely avoided. On fully enclosed wagons, the load direction of the cars must be indicated on both sides of the wagon by means of an arrow (applied with chalk or sticker) to facilitate the unloading procedure.
- A loading plan should be drafted before the loading begins and followed throughout the loading process.

- Wagons must be secured by applying the brakes and by using brake shoes so that they don't roll away during loading/unloading.
- Wagons have to be prepared for loading: the upper deck must be moved to the loading/unloading position and secured.
- Bridging plates must be in place and fully secured.
- Gaps between wagons or wagon sections must be such that no damage can occur to the vehicles' tyres. Removable drive-on ramps or track are to be attached when necessary to the fittings provided on the wagon.
- Check that the loading width of the wagon is sufficient for the track of the vehicles being loaded.
- Check the vehicle's height to see if it can be loaded onto the wagon. Some vehicles can only be transported on the top deck. Vehicles stowed on the top deck must be low enough to prevent any danger of touching the electric lines.
- It is absolutely forbidden to access the top deck or load/unload if there is an electrical line overhead.
- It is forbidden to step on either of the decks while the upper deck is being raised or lowered.
- Before loading/unloading, the deck must be free of any materials that might cause damage to the vehicles to be carried (wire, glass, stones, wheel chocks). If possible, snow and ice should also be removed.

3.2.2. During loading or unloading

- During loading and unloading operations, vehicles must be driven at walking speed, both on the ramps and on the train, to reduce the probability of damage. Speed must be particularly reduced before driving onto or off the ramps.
- Cars should be loaded or unloaded only by driving forwards. Reversing them onto/off the wagons could cause damage. By exception, loading by reversing is acceptable for the last vehicle on the deck, but only if loading forwards is impossible.
- The upper deck should be loaded before the lower deck and unloaded after it.
- It must be checked that the following distances are kept:
 - In single wagons or group of wagons, between the cars, bumper to bumper, or bumper to fixed wagon structure: not less than 15 cm
 - In full block trains, between the cars, bumper to bumper, or bumper to fixed wagon structure: not less than 10 cm

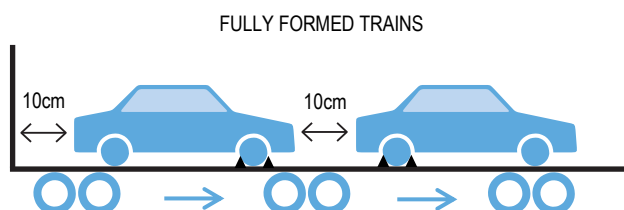
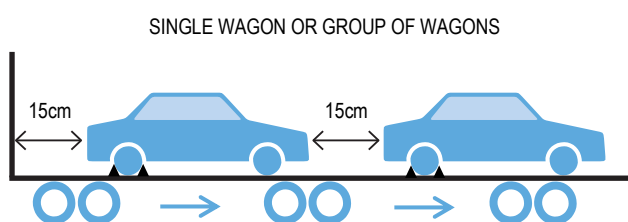

- Between the cars, bumper to bumper, over or next to a short coupling, in the area where the axle is not chocked: not less than 26 cm

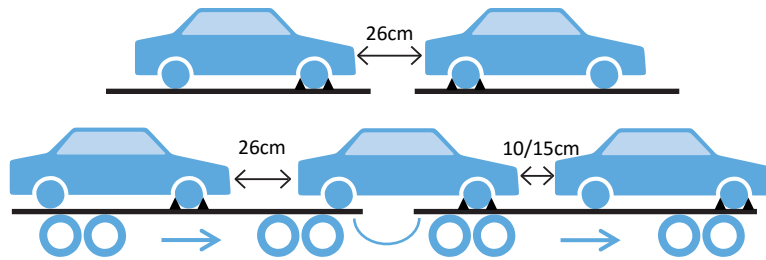

- Between the cars, bumper to bumper, over or next to a permanent coupling, in the area where the axle is not chocked: not less than 40 cm

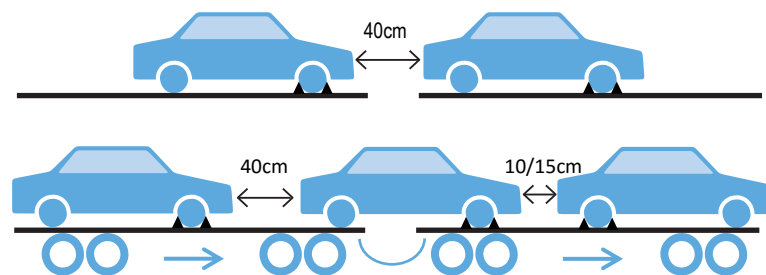

- Clearance between the vehicle's roof and the upper platform: 8 cm (use your fist as a measure)

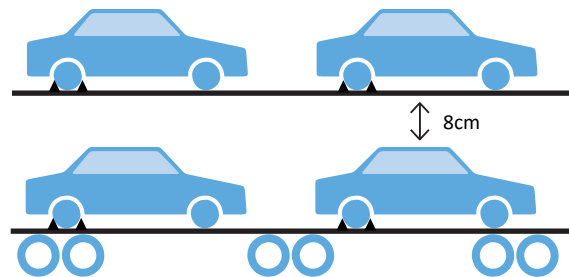

- A minimum clearance must be kept above the roof of the cars stowed on the upper deck to avoid damage from bridges and tunnels and contact with electric lines. Cars with removable aerials that are loaded on the upper deck must have this aerial removed during transport.
- Vehicles loaded over joining parts of the train (short couplings or permanent couplings) can only be put into gear together with the handbrake on when they both block the same axle. Otherwise, only one of the two can be used to allow for extra movement over the coupling.
- All other vehicles should be secured by both engaging the first gear (or putting the transmission selector lever in "P" position for vehicles with automatic transmission) and applying the handbrake.
- Vehicles with pneumatic suspension must be transported according to the manufacturer's recommendations.

3.2.3. After loading or unloading

- After loading/unloading, the wagon has to be put in transport mode: bridging plates at both ends of the wagon have to be put in the upward position and secured (in fully enclosed wagons, doors should be closed and secured). Unused chocks should be secured on the wagons to avoid them falling or being lost on route.
- If the cars have been loaded/unloaded during the night or under any other conditions that demand the use of headlights, they have to be switched off immediately after loading/unloading.
- Keys must be removed from the ignition and stored in the door pocket on the driver's side or in accordance with the manufacturer's instructions.
- Cars must be lashed for transport according to the lashing procedures defined in the next section.

3.3. Lashing

- All transported vehicles must be secured with wheel chocks.
- As a general rule, four wheel chocks per vehicle should be used.
- Wheel chocks are to be placed both behind and in front of two wheels on the same axle
- The axle to be secured by wheel chocks is the one on which the handbrake and/or gear is applied.
- For vehicles placed over short or permanent couplings, the above rule must absolutely be respected. Under no circumstances can a car placed over a coupling be secured with wheel chocks on both axles!
- On some routes and in some countries (but only for domestic transport), vehicles can be fixed with two chocks on one wheel or a double chock, protecting the wheel from the front and from the back, on one wheel. It must not be forgotten that this rule is an exception. Before applying it, it has to be checked whether the lashing codes on the selected route allow for such a solution.
- The wheel chocks are to be placed and removed carefully in order not to damage the tyre.
- If a lever is used to remove the chock, it must be properly protected to prevent damage to the vehicles.
- A gap in accordance with the technical requirements for the chock type used must be left between the chock and the tyre.
- The chock must never touch any part of the car other than the tyre.

4. Water Transport

- In general, only purpose-built car carrying sea-going vessels and inland waterway barges can be used for transporting new vehicles. The security and quality rules that follow apply integrally on this kind of vessels.
- If the manufacturer agrees, cars can also be transported in containers. However, it has to be noted that cars transported in containers are exposed to a significantly higher damage risk. The quality and security standards are then subject only to the local minimum legal requirements and to the contractual agreement negotiated with the logistics services provider.

4.1. Purpose-built sea-going car-carrying vessels

4.1.1. Equipment

4.1.1.1. Ships

- Ships used for transport of vehicles must be in good physical condition. The manufacturer has the right to impose stricter conditions and refuse those ships that do not meet them.
- Ships must respond to internationally recognised quality standards.
- The decks and ramps of the ships must be constructed in such a way that there is sufficient distance between inner pillars for easy, damage free loading and unloading.
- Any gaps in the decks or between ramps and decks, as well as any perpendicular differences in height must be reduced to a minimum to preclude damage to tyres.
- It has to be checked that no pipes or any of the ship's equipment (deck lifter, fork lift, etc.) are leaking oil.
- All elements on/of the decks should be rust free. In no case should rusted elements enter into contact with the transported cars.
- The holds in which cars are stored must be clean, odour free and adequately ventilated. All traces of chemical or greasy substances must be removed.
- Decks and ramps must be well lit. All obstacles (obstructions, stanchions, etc.) must be painted or marked in safety colours. The construction elements most likely to be accidentally run into with cars must be padded to minimise the probability of serious damage.
- All internal and external connecting and access ramps must be set at a sufficiently low angle to enable easy access and prevent damage to front bumper valances and the underbody of the transported vehicles. The recommended maximum ramp angle is 8 degrees.
- All connecting and access ramps should offer good grip but may not be sharp edged.
- Additionally, it is recommended to apply antiskid tapes/painting to driveways in the turning points.

AMENDED

4.1.1.2. Ship equipment

- Ship and quay operations must ensure adequate stocks of jump leads, premium/super unleaded fuel and diesel fuel to enable non-starters to be loaded and unloaded without

problem.

- The vessels must be equipped with sufficient lashing points.
- Mobile chains must be properly taut, so that they do not become more tensioned and touch the underside of the vehicles.
- The vessels must be equipped with a sufficient number of car lashings in good technical condition. The lashings' resistance capacity must be adapted to the type of vehicle transported with a sufficient safety margin.
- Metal parts of the lashings should be protected to preclude damage.

4.1.2. Loading/Unloading

The following rules are specific to the loading/unloading process. Even so, the rules on car handling listed in the general section (Section 1.2.) also apply. Personnel must also be trained on these instructions before being allowed to proceed with loading, unloading or other handling.

4.1.2.1. Before loading or unloading

- It is the responsibility of the Stevedoring company to organise a meeting involving the Captain and/or Chief Officer of the vessel and the Port Captain to draft a loading/stowage plan. This plan then has to be followed throughout the loading process.
- Before loading, enough driveways and walkways have to be clearly designated and marked, according to the ship's safety requirements.
- The ramps and decks must be set in the correct position for loading/unloading and the internal doors must be opened.
- Decks and ramps must be freed of all loose equipment. Lashings must be secured or stored. In no case can the lashings be left hanging from the bulkheads / stanchions without being secured.

4.1.2.2. During loading or unloading

- All loading/unloading operations must be co-ordinated by an experienced supervisor
- Ramp angle should be observed during loading (as it may change because of the tide and the change in ballast when cars are loaded/unloaded).
- Vehicles must be loaded in groups of vehicles of similar dimensions to facilitate their positioning on the loading deck.
- A safety distance adapted to the speed must be kept between vehicles ahead and behind when driving on the ramps and decks.
- Before driving onto a ramp, the front man of a gang of vehicles must ensure that the ramp is free on its entire length. No other vehicle can drive onto the ramp before the whole gang has passed.
- Inside the ship, speed must be limited to such an extent as to preclude damage
- Moreover, drivers have to comply with the shipping line's imposed speed limits. However, ramps should be negotiated at a sufficient speed to prevent wheels from skidding on wet

surfaces

- Headlights must be turned on at all times during loading and unloading and then be switched off afterwards.
- Cars with pneumatic suspension must be driven in the highest suspension position and stored in the lowest.
- All vehicles must be stored below deck. Any exception to this rule must be accepted by the manufacturer by way of a written contract, agreement or instruction.
- The direction in which vehicles must be (un)loaded (clockwise or anti- clockwise) must be determined by the port captain before the (un)loading starts and applied in a consistent manner. When loading is finished, the cars of a block that are situated in the most external positions must be easily accessible from the driver's side (enough space must be left for the driver's door to be opened without damage).
- During loading/unloading, cars should be driven forwards. Excessive manoeuvring and reversing should be avoided.
- As far as possible, cars should be stowed longitudinally. This way, the risk of the cars being displaced during lateral movements of the ship is minimised. If transverse storage cannot be avoided for some cars, special security (lashing) measures must be undertaken, according to the lashing instructions in section 4.1.3.
- In case of any constraint, apply the strap or hook to the next available wheel hole / branch.
- It is best practice for the maintenance of quality and productivity to group cars by destination and model size for efficient stowage prior to loading. For ocean transportation stow plans should be created to ensure that vehicles in stow follow a controlled flow process so door opening at break from stow at destination is always into clear space, avoiding the risk of door contact with other cargo or vessel structure.
- Manufacturer's recommendations on which cars can be stored on ramps or transversely must be respected.
- New cars must be stored separately from other cargo and/or used vehicles.
- Cars should be unloaded in the opposite order to loading: the last car to be loaded is the first to be unloaded.
- It must be checked that the following distances are kept:
 - Between the cars, bumper to bumper: a minimum of 30 cm
 - Between the car's bumper and the ship's superstructure: 30 cm
 - Between the cars, mirror to mirror: 10 cm
 - Clearance between the vehicle's roof and the upper deck: 10 cm
 - Between a car and other automotive and non-automotive cargo: 50 cm
 - Between the car (passenger's side) and the ships superstructure: 15 cm
 - Between the car (driver's side) and the ship's superstructure: 60 cm

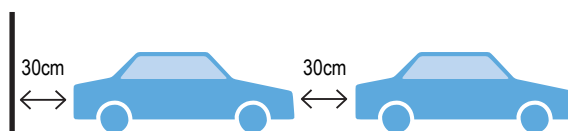

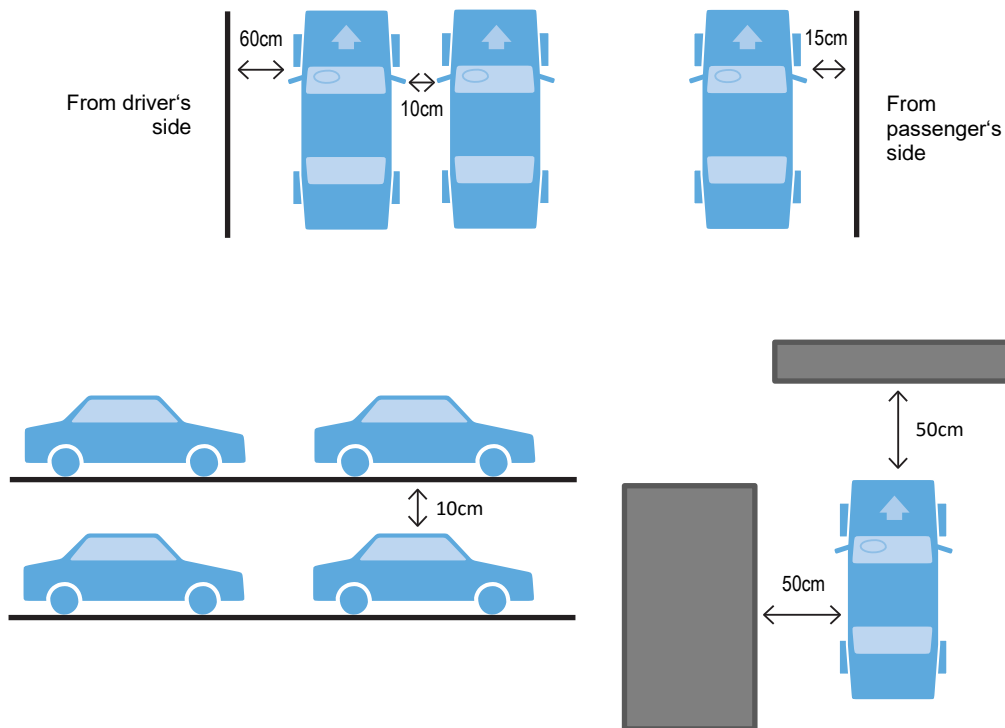

4.1.2.3. After loading or unloading

- After loading/unloading, vehicle headlights must be switched off immediately.
- When leaving the vehicle after loading, check to ensure it doesn't stand on any chains, wires, lashings or any other object that could damage the tyres. Wheels must be left in the straight ahead position.
- If the vehicle is equipped with a battery disconnection switch it has to be activated once the vehicle has been parked in position on board of the vessel.
- Vehicles that can't be unloaded under their own power, even after refuelling and/or jump-starting, must be towed by a specialised car and following manufacturer's instructions. Under no circumstances may a broken-down car be towed by another car from the load.
- After loading cars must be lashed according to the procedures defined in the following section.
- Lashings should be inspected and corrected (re-tensioned) in case of necessity at least every day during the first three days and then every third day. If heavy weather is expected, daily checks should be re-established.
- Vehicles with manual transmission must be engaged in 1st gear and have the hand brake (parking brake) applied.
- Vehicles with automatic transmission must have the transmission selector lever in "P" position and have the hand brake (parking brake) applied.
- Vehicles should be kept unlocked during transport. Keys must be removed from the ignition and stored in the door pocket on the driver's side, if possible.

4.1.3. Lashing

- If a vehicle transported on a ship required lashing, it should be done in accordance with:
 - the Customer's requirements
 - the IMO (International Maritime Organization) regulations
 - the Cargo Securing Manual of the vessel
 - the satisfaction of the vessel's command as the Master is ultimately responsible for the cargo during transit and the seaworthiness of the vessel.
- Each vehicle must be secured by two lashings at each end (regulations on short sea routing might be different). These lashings are to be applied to the vehicle's points specifically designed for the purpose and recommended by the manufacturers. Use of unauthorized lashing points is not permitted.
- Vehicles stowed transversely or on ramps must be lashed with a minimum of three lashings at each end (two belts per wheel in case of lashing on wheel rims) and also additionally secured with wheel chocks (non slip wedge);
- It is not recommended to mix the two methods of lashing on an individual vehicle, i.e. to use both rim and towing eye;
- Heavy vehicles must be secured by additional lashings with due consideration of the weight.
- Some examples of lashing configurations are shown in the pictures below:

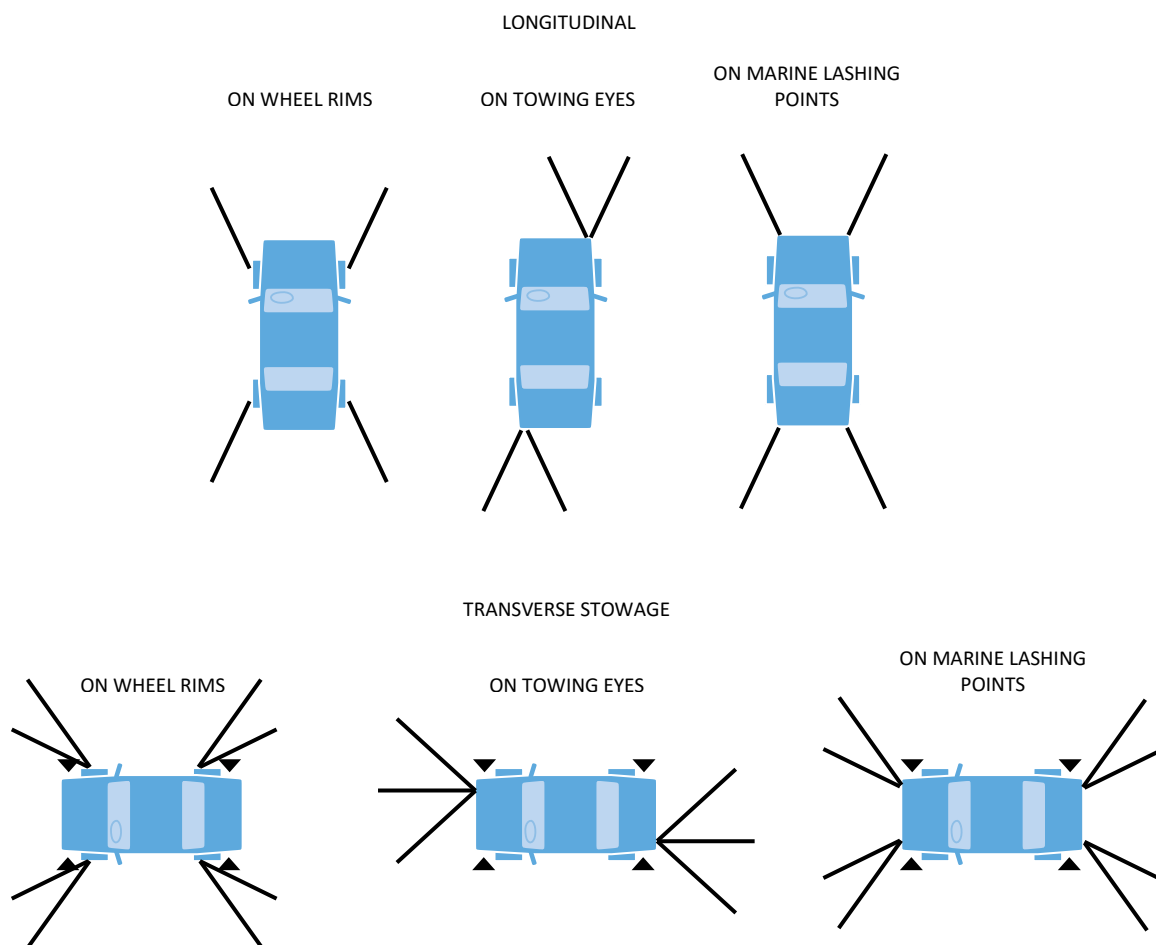

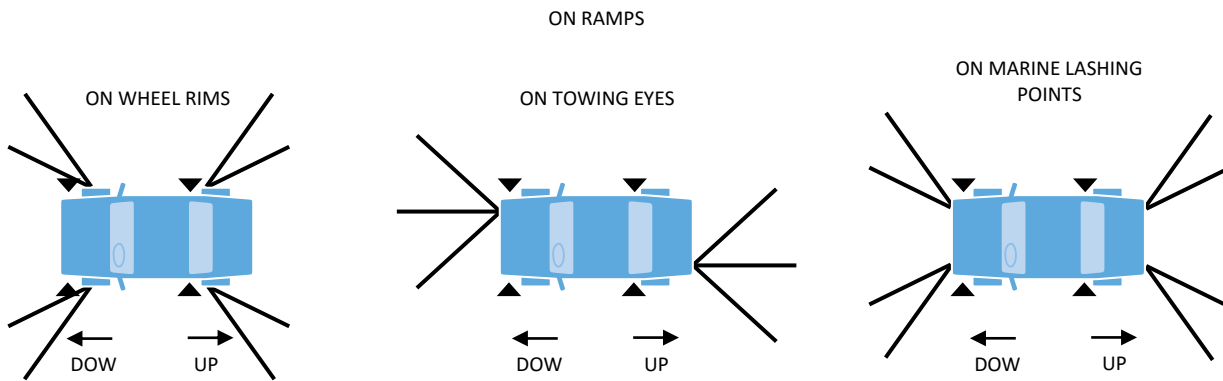

4.1.3.1. General lashing procedures

- Lashings must be handled in a way to preclude any damage to the transported cars.
- The lashings used to secure a vehicle must not touch any other part of the vehicle other than the lashing point or any other vehicle after they have been properly tightened.
- A vehicle must be lashed immediately after it has been parked for storage and unlashed only after reaching the port of arrival.
- Lashings should be tensioned sufficiently to preclude the vehicle from moving, but shouldn't tighten the car down on its suspension.
- Vehicles must be lashed at an angle of – if physically possible – 30-60 degrees to the longitudinal axis of the vehicle to prevent lateral shifts during transport. Both at the rear and in the front, at least one lashing must be attached to a lashing point at each of the sides (left and right) of the vehicle. This way, the car is protected from lateral movements in any direction.
- Vehicles must be lashed either on the rims or on the towing hooks, according to the manufacturer's requirements.
- There should be no contact of the strap with the tyre valve, or any bodywork element.

SECURING ALLOY WHEELS 1 belt with strap or loop extension on each wheel

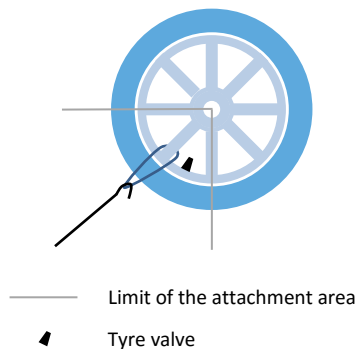

- There should be no contact of the hook with the wheel, tyre, brake calliper, balancing weight or any bodywork element

SECURING STEEL WHEELS
1 belt with flat hook attached to each wheel

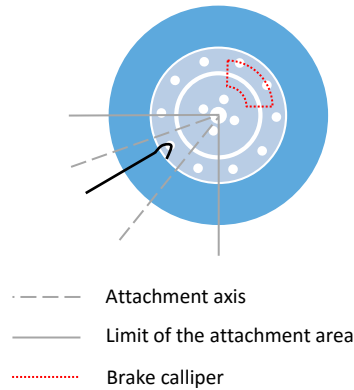

4.1.3.2. Wheel rim lashing

- Cars can be lashed on the rims only if the manufacturer allows it.
- Cars can be lashed on aluminium and steel rims. In the case of steel rims, the plastic wheel protectors have to be removed from the wheel before the car is lashed to prevent damage to them.
- If lashing on alloy/aluminium rims, fit the loose nylon loop around a wheel spoke and insert the hook into the loop with the hook opening facing downwards. If lashing on steel rims, attach the plastic protected hook directly to the rim, with the hook opening facing downwards.
- For the lashing to be effective, the lashing must be attached to the lower part of the wheel, and it must be aligned with the centre of the wheel. If these conditions are not respected, the wheel might turn during transport and the lashing might become loose.
- Ship's command should apply the best practice keeping loading and lashing sequences with proper timing to avoid any walking between parked vehicles.

SECURING STEEL WHEELS
1 belt with flat hook attached to each wheel

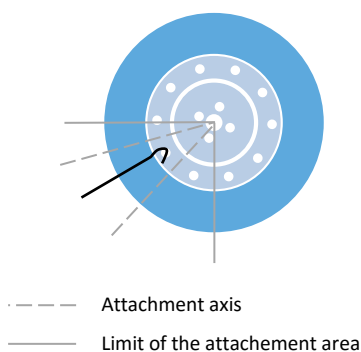

SECURING ALLOY WHEELS
1 belt with strap or loop extension on each wheel

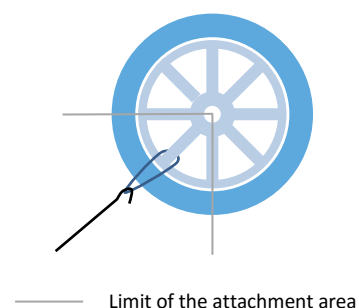

4.1.3.3. Towing eye lashing

- Cars can be lashed by the towing eye if the manufacturer allows it, and if front and rear eyes are available.
- Lashing a vehicle on towing eyes includes the following steps:
 - The shorter end of the car lashing is to be hooked in the towing eye of the car
 - The other end of the lashing is to be anchored to the deck
 - The lashing is to be locked by pulling at an angle.
- At least two lashings must be attached to each of the towing eyes.

4.2. Special provisions on Lo-Lo and Ro-Lo vessels designed for car transport

On vessels specially designed for car transport, on which all or part of the decks are not directly accessible to rolling cargo, the rules listed above equally apply. However, in order to limit damage probability, special procedures must be applied for loading:

- Vehicles cannot be loaded or unloaded using a standard crane. A cradle specially designed for lifting vehicles must be used.
- If the cradle is designed for lifting two cars at a time, cars must be loaded by two, never alone.
- When lifted by the cradle, vehicles must have the handbrake applied and be in neutral gear. The engine must be turned on.
- As soon as they are on board the vessel vehicles must be handled according to the same rules that apply on a Ro-Ro vessel. In particular, cars can never be stowed on top of other cargo or containers!

4.3. Special provisions on transport in containers

- All containers used for car transport must meet the relevant ISO standards.
- **AMENDED** There are 3 generic solutions to transport vehicles in a container:
 1. Flat (1 or 2 vehicles),
 2. On a palette adapted to vehicle transport (1 or 2 palettes tied to the ground and to one another)
 3. Using a mechanical system (from 3 vehicles).
- **AMENDED** It is possible to use special containers adapted to the transport of cars (containers with removable side walls or open containers) instead of standard closed containers. Indeed, certain cars are too wide to be safely loaded in a standard container, as the driver has very little space to leave the car after loading.
- **AMENDED** Refrigerated containers (reefers) may be used with specific conditions applied as it is not possible to nail into the floor. It is imperative to use moveable lashing methods that do not damage the floor.

- Standard containers must not have any holes and must be tightly closed to avoid salt water damaging the transported cars.
- NEW** • Open containers always have to be placed in the cargo hold in order to avoid any deterioration of the vehicles by salt water.
- AMENDED** • In closed containers, special protection must be fixed between the container wall and the driver's door to prevent any damage.
- AMENDED** • Cars transported in containers must be properly lashed with four lashings, to avoid sideways or upwards movement, according to the instructions listed in section 4.1.3.
- Securing the car can be done by wheel lashings (rims) or using towing eyes (screwed or welded), according to the OEM instructions.
- AMENDED** • It is strongly advised to additionally secure the cars in a container by using wheel chocks. (This is mandatory in the absence of adequate lashing points in the container.) First, these chocks must be nailed into the floor in the back of the container. The car then should be placed in such a position that its wheels on one axle are blocked by the chocks. An additional pair of chocks should be nailed into the floor in the front of the container to block the wheels on the other axle.
- AMENDED** • If cars are to be stacked inside the container, the maximum angle at which they are stacked is advised to be 25 degrees. Some manufacturers impose other maximum angles to be respected in order not to cause the leak of potentially corrosive liquids.
- AMENDED** • Clearance between the cars and the container walls should be 10 cm; 30 cm at the front and back of the vehicles and 10 cm in height between the vehicle's highest point and the roof.
- A quality control before loading and just after unloading should be performed to define the transfer of responsibility. It is recommended to proceed with the inspection of the vehicles before any unloading operation begins (within the container if possible). The control should be carried out jointly between the different parties concerned according to incoterms and the liner terms of sale. A record of the noted damage shall be established. The control can be entrusted to specialised companies.

4.4. Specially designed Ro-Ro river barges

4.4.1. Barges

- Barge decks and loading/connecting platforms must be in good physical condition, clean and rust-free.
- Loading platforms must offer good grip but not be sharp edged.

4.4.2. Loading/Unloading

4.4.2.1. Before loading or unloading

- Loading platforms must be placed at a sufficiently low angle to enable easy access and prevent damage to the underbody of the transported vehicles. The recommended maximum ramp angle is 8 degrees.
- Before loading starts, the leader of the stevedoring shift and the captain must check whether among the vehicles to be loaded any are leaking oil and could damage the vehicles stored on lower decks.

- For safety reasons, a pathway at least 60 cm wide must be left free on the whole length of the barge on the lower deck.
- Loading or unloading can start only after the captain has given his explicit permission.

4.4.2.2. During loading or unloading

- All loading and unloading operations must be co-ordinated by an experienced supervisor.
- As far as possible, cars should be stored longitudinally. If transverse storage cannot be avoided for some vehicles, they must be secured with wheel chocks.
- Vehicles must be loaded and unloaded at walking pace. They must be manoeuvred carefully in order to avoid damage.
- The slope of the loading ramp must be observed and corrected during loading/unloading, so that the ramp doesn't become too steep because of the change in ballast and provoke damage to the underbody of cars.
- Vehicles must be loaded in such a way and such an order that each vehicle, when parked for transport or entered for unloading, can be accessed through the driver's door without any risk of touching neighbouring vehicles. Vehicles can only be entered/left through the driver's door, never through other doors or the window!
- Barge loading should be planned so that it always allows door opening during break from stow into clear space avoiding the risk of door contact with other cargo or barge infrastructure.
- It must be checked that the following distances are kept:
 - Between the cars, bumper to bumper: 15 cm
 - Between the car's bumper and the ship's superstructure: 15 cm
 - Between the cars, mirror to mirror (with closed mirrors): 10 cm
 - Clearance between the vehicle's roof and the upper deck: 10 cm
 - Between the car (passenger's side) and the ship's superstructure: 10 cm
 - Between the car (driver's side) and the ship's superstructure: 60 cm.

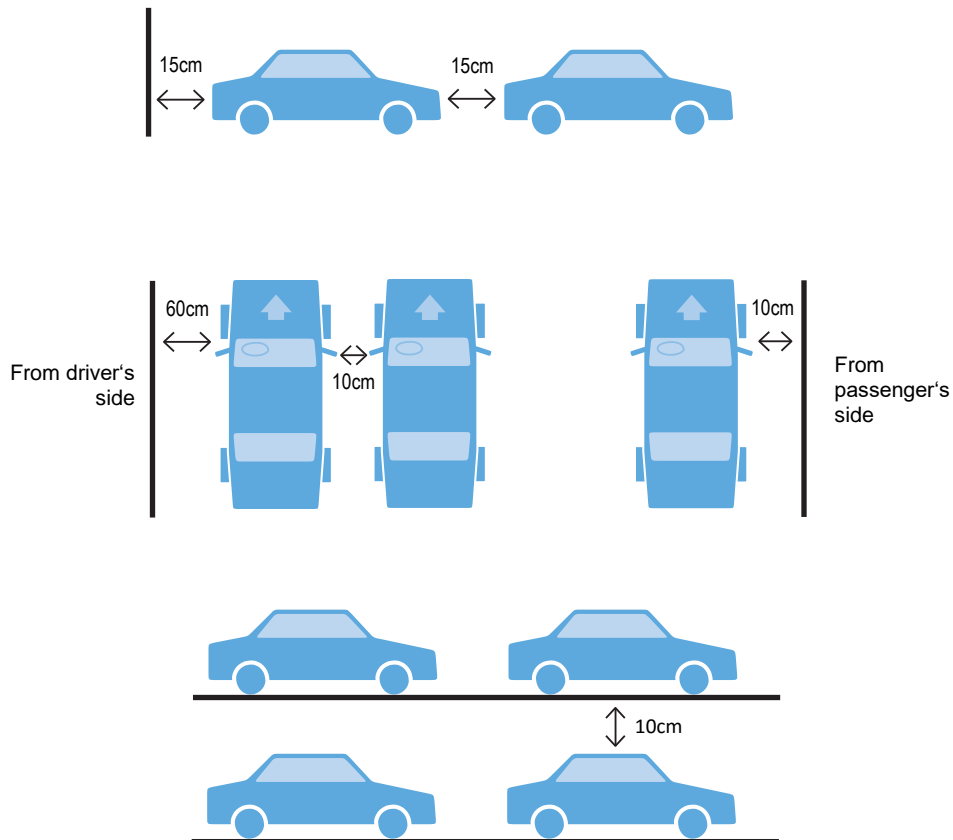

4.4.2.3. After loading

- Windows and doors must be kept closed but not locked. Keys must be removed from the ignition and stored in the door pocket on the driver's side.
- Vehicles must be left with the hand-brake on and first gear engaged. Vehicles with automatic transmission must be left in "P" position.
- Vehicles stored on ramps must be effectively secured with wheel chocks to prevent their slipping.

5. Compounds

5.1. Technical requirements

5.1.1. Yard design

- All areas of the compound must be coated with asphalt/concrete or paved.
- Compound surfaces must be pot hole free.
- Compound yards must be properly drained.
- All compound areas must be clean. Removal of loose objects/debris from the ground must be performed at regular intervals.
- Compounds must be sufficiently lit. Lighting posts and other obstacles must be cushioned around their lower parts for damage prevention.
- In the case of port terminals, compounds should be protected from saltwater spray.
- All vegetation must be systematically removed from the compounds and their immediate surroundings. Parking cars under trees is strictly forbidden as resin and leaves can seriously damage car paint.
- Compounds must be divided into separate areas dedicated to:
 - Car storage
 - Truck loading/unloading
 - Truck rest (if trucks are to be parked for long periods on the compound)
- Port compounds must additionally contain a sufficiently big area dedicated to load forming and bulk dispatch.
- Personal car parking must be separate from the rest of the compound.
- Car parking (storage) bays must be designed according to the parking instructions presented in section 5.2.2. and clearly painted on the ground. Moreover, each parking bay must be fully identifiable by a clearly indicated, easy to follow system of numbering and lettering.
- Internal ramps and slopes must be sufficiently flat to prevent damage to the underbody of the vehicles. The recommended maximum ramp angle is 8 degrees.
- Protection against natural sources of damage is recommended. In any case, compound operators should have action plans for all adverse weather events.

5.1.2. Yard equipment

- The compound must be equipped with a sufficient number of hydrants and fire extinguishers according to the fire protection regulations of each country.
- There must be a sufficient number of sets of jumpstarting equipment in good condition.
- Portable tyre pressure checking equipment must be available on site.

- There must be a sufficient reserve of fuel (diesel and unleaded petrol) on the compound.
- Additionally, vehicle identification systems must be available on-site for fluid stock management.
- Other yard equipment elements (battery testing equipment, compressors, car wash) may be required by the manufacturer and must be available on site if the contract so stipulates.

5.1.3. Safety measures

- Compounds must be surrounded by a fence of at least 2 metres in height. It is recommended for the fence to be topped with barbed wire.
- Natural (steep hills, dense vegetation) or artificial (concrete/stone base) obstacles should complement the fence in anti-theft protection.
- The compound entrance must be equipped with a gate barrier and must be guarded.
- The whole compound area must be under constant camera supervision or a similarly effective surveillance system. Moreover, it must be patrolled by security personnel.
- Access to the compounds must be restricted to the personnel. Visitors' access to the compound must be subject to individual authorisation.

NEW

5.1.4. Yard lighting

- Minimum lighting requirements for outdoor working places in the European Union are defined in EN 12464-2:2007. The compound must be lit at least to these requirements or if so requested to the lighting requirements determined by the OEM.
- Light requirements for safety and health of workers may be contained in Directives based on Article 137 of the EC treaty, in national legislation of Member States implementing these directives or in other national legislation of Member States.
- Direct and indirect glare are to be avoided to ensure safe operations on and off-site not only during loading and unloading but also during other operations on site such as handling of vehicles and safety surveillance.
- For easy car identification and a convenient work environment light systems should provide for high colour rendering levels of Ra 65 and above.
- Spill light on adjacent areas and, in particular, residential buildings is to be avoided in order to minimize the environmental impact of yard operations and being a "good neighbour". Spill light is wasted light and thus wasted energy.
- Coefficient of utilization (CU = Light on area / Lamp lumens generated) should be applied in determining efficiency of a lighting system
- A sustainable light system:
 - Operates at lowest energy consumption levels possible
 - Has a high coefficient of utilisation
 - Reduces spill and glare
 - Operates at lowest total cost of ownership

5.2. Storage

The rules in this section concern specifically car handling in compounds. Still, the rules on car handling listed in the general section (Section 1.2.) also apply. Personnel must also be trained on these instructions before being allowed to proceed with vehicle handling.

5.2.1. General storage rules

- Cars with manual transmission must be secured by engaging first gear.
- Cars with automatic transmission must have the transmission selector lever in “P” position.
- The handbrake must be released.
- Ventilation traps should be left open.
- Writing on the windscreen and/or windows is forbidden. Easily removable stickers can be used if allowed by the manufacturer and only in specifically indicated areas.
- Cars left for storage must have their keys removed from the ignition. Keys must be managed according to the manufacturer’s requirements.
- It is forbidden to change the original folded position of the exterior mirrors.
- For longer storage, the battery should be disconnected.

5.2.2. Parking

- Vehicles must be parked with their left tyres over the left parking line, or in another consistent manner.
- ‘It is best practice that left and right hand vehicles should be grouped in separate lanes with opposing driver doors opening into clear space.
- Vehicles should be parked in the compound according to one of the following patterns:
 - Herringbone
 - Bumper to bumper

The design of the storage area must take into account the following minimum measures between the vehicles:

HERRINGBONE

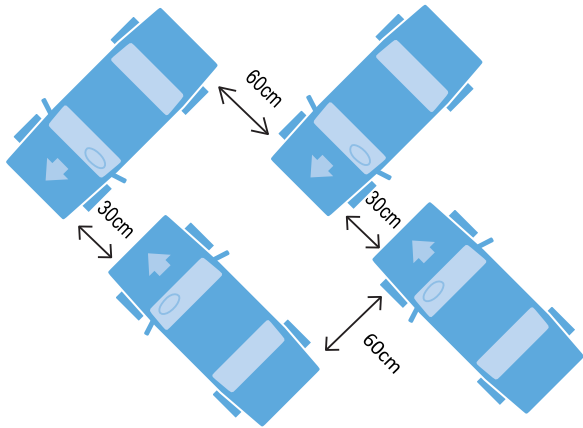

BUMPER TO BUMPER

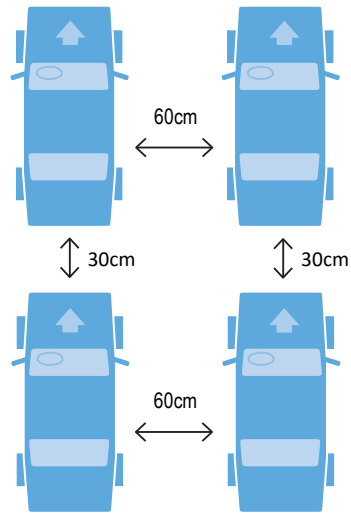

- In storage, direct shipping and loading zones:
 - Between the cars, bumper to bumper: 30 cm
 - Between the cars, side to side (excluding mirrors): 60 cm.

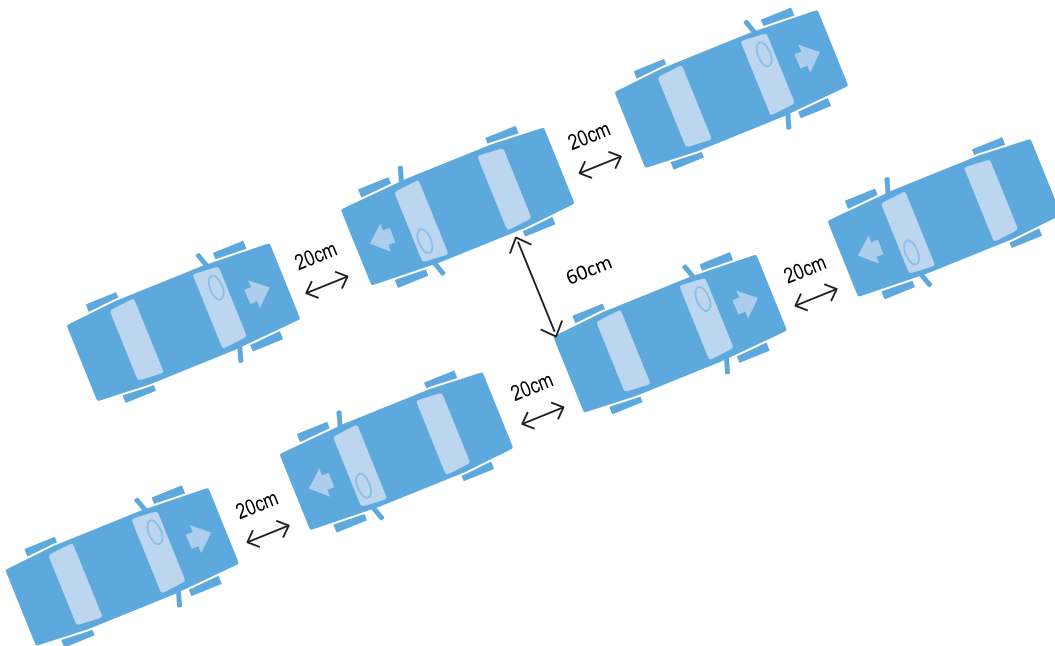

- For block shipping:
 - Between the cars, bumper to bumper: 20 cm
 - Between the cars, side to side: 30 cm.

If vehicles are going to be inspected before loading or employees need to pass between the vehicles, the side separation must be a minimum of 60 cm.

5.3. Maintenance and workshop / PDI centres

- The following basic rules should be applied for all kinds of workshop operations in the vehicle logistics chain such as PDI (Pre-Delivery Inspection), PPO (Post-Production Options), repairs etc.
- The workshop must be clean, sufficiently well-lit and frequently cleaned.
- New vehicles undergoing their PDI/PPO must be separated from vehicles undergoing repairs, in order to avoid all risks of pollution by the repair operations (dust, sparks, oil stains on the floor...)
- The operators' clothes must be clean and suited to the job. They must not have sharp edges such as metal buttons, rivets, zips, metallic belt buckles, etc. It is recommended to wear high visibility jackets while working in a PDI centre.
- The standard clothing requirements apply and operators must not wear any keyrings, sharp objects, bracelets or rings. Watches and belts can be worn as long as a protective device is used. More information on clothing can be found in Chapter 1.1.
- Sufficient gaps must be left between the vehicles to avoid any damage. The doors of the car should be able to be fully opened on each side.
- For any vehicle entering the workshop for repairs, the driver's seat, the steering wheel and the floor mat must be protected.
- The vehicle's windows must be closed.
- It is necessary to protect openings in the passenger compartment with tape, protective dust sheet or other means in order to avoid dust or paint entering the vehicle (very important in bodyshop/paintshop).
- The key(s) or keycard(s) must be removed from the ignition and placed in the map pocket of the driver's door (or in the storage tray in the central console if the vehicle is not fitted with door pockets). If they are linked at factory the link should not be broken - under no circumstances should keys be separated from one another in the workshop.
- Any parts removed from a vehicle must be packaged and stored (in appropriate racks). The parts must always be placed with their 'visible' surfaces face up so they do not come into contact with the rack itself. Parts must never be placed on top of each other as this can result in damage.
- No storage of parts is allowed inside the vehicle itself. No tools, or parts removed from the vehicle, can be placed in the passenger compartment or on the bodywork of the vehicle.
- The tool trolley must be kept at a sufficient distance from the car to avoid any risk of damage. Trolley wheels should be locked to avoid any unintended movement. The racks and trolleys need to be padded (protected) in order not to cause damage to vehicles. This protection must be reviewed regularly to ensure it is adequate.
- All equipment used must be in a suitable condition and in good working order. Tools must be subject to a maintenance programme if required (e.g. torque wrenches). It is recommended to clearly label such tools containing details of the last/next calibration/control of the tool.
- Tool maintenance should be carried out in compliance with industrial guidelines or the manufacturer's instructions.
- Any exterior transport protection from a vehicle must not be replaced or repositioned (risk of damage due to dirt contamination). Partially damaged or dirty exterior transport protection must

be removed immediately to avoid any damage.

Recommended workshop minimum dimensions

Type of vehicles	Work bay
Passenger car	5m * 6m = 30m ²
LCV	5m * 7.5m = 37.5m ²

NEW

5.4. Compound auditing

- Self-auditing of compound and transport modes infrastructure, environment, management and operational handling should be regular enough to identify deficiencies, non-conformance and training needs.
- It is important to seek continuous improvement as a minimum to the ECG standard whilst seeking to maximise service levels, damage free delivery and cost reduction.

5.5. Training

- The compound operator is entirely responsible for the implementation of the quality standards in this manual.
- In order to achieve the best quality results the compound operator must regularly train his staff in respect to the quality standards expressed in this manual.
- In port compounds the compound operator must make sure that the stevedore company complies with the quality standards.
- It is recommended that the compound operator designate a quality manager to be responsible for the implementation of the quality standards on the compound and to stay in contact with the manufacturers.

6. Handling of Alternative Fuel Vehicles (AFVs)

6.1. General

- This chapter covers Alternative Fuel Vehicles (AFVs), which include Electric vehicles, Hybrid vehicles, Hydrogen Fuel Cell vehicles, Compressed Natural Gas (CNG) vehicles and Liquefied Petroleum Gas (LPG) vehicles.
- Always assume the vehicle is powered, even if it is silent.
- Never touch, cut or open any orange high voltage cable or high voltage component in an Electric, Hybrid or Hydrogen Fuel Cell Vehicle. These cables are also marked with a high voltage sign.



- Do not damage the battery pack, even if the propulsion system is deactivated.
- Some OEMs currently mark their AFVs so that they are easily recognisable in the supply chain. This is not general practice, however it is regarded as best practice.

6.2. In case of accident or fire

6.2.1. Electric & Hybrid Vehicles

- A damaged high voltage battery can create rapid heating of the battery cells. If you notice smoke coming from the battery, assume it is overheating and take appropriate action.
- A burning or overheated battery releases toxic vapours. These vapours include sulphuric acid, oxides of carbon, nickel, lithium, copper, and cobalt. Responders should protect themselves with full personal protective equipment (PPE), including self-contained breathing apparatus (SCBA), and take appropriate measures to protect people downwind from the incident.
- A Lithium-Ion battery has a behaviour that requires special firefighting tactics. Instead of stopping the thermal runaway by extinguishing the fire, focus should be on preventing the fire from spreading. This could for example be done by cooling the fire and the adjacent vehicles using water.
- If the high voltage battery becomes involved in fire or is bent, twisted, damaged, or breached in any way, or if you suspect that the battery is overheating, use large amounts of water to cool the battery. Do not try to extinguish fire with a small amount of water. Always establish or request an additional water supply.

6.2.2. Hydrogen Fuel Cell Vehicles + Compressed Natural Gas

- Hydrogen and methane (natural gas) are highly combustible, explosive gases, which are invisible, odourless and tasteless, and are far lighter than atmospheric air.
- The flames in a hydrogen fire are difficult to see in daylight – use a thermal imager. In the event of a fire in the form of a jet flame from a pressurised tank, it is important to establish the spread of the fire.
- If there is a fire in escaping hydrogen, the flame should only be extinguished if it is possible to halt the escape. If the jet flame threatens other objects, these can be cooled.
- In case of fire, do not use extinguishers containing water. Extinguishers for electrical fires - such as CO₂ - can be used.
- Hydrogen ignites more easily than gasoline, however, it is lighter than air and disperses quickly. Even if hydrogen were to leak from the system, it would quickly disperse until it is no longer flammable, unless in a contained unventilated area, e.g. on a barge or ship.
- If a large amount of leaking hydrogen gas is noticed, the power switch must be turned off, the vehicle has to be exited and the driver has to stay away from it. Assistance should be called if possible.
- To avoid an explosion of the escaping hydrogen, the hydrogen circuit must be deactivated and all ignition sources have to be kept away from the vehicle.
- In many Hydrogen Fuel Cell models (e.g. Honda, Hyundai, Daimler, Toyota) and CNG vehicles, if the temperature inside the Hydrogen tank exceeds 108-110°C, the gas in the tank will be released through a pressure relief valve. It may make a hissing sound and take some minutes till the tank is empty.
- In the event of a pressure relief valve activation there could be an ignition of the gas outflow resulting in a jet flame. Firefighters need to stay clear of a potential jet flame and if it occurs they shall not extinguish it. They should wait and cool adjacent objects in order to stop the spread of the fire.

6.3. Transport modes

6.3.1. Road transport

- ADR (European Agreement concerning the International Carriage of Dangerous Goods by Road) doesn't apply to battery-powered vehicles (UN number 3171).

6.3.2. Rail transport

- AFVs can be transported anywhere on a wagon, so even in the middle of the wagon or on a moving platform.
- Usually, the transmission blocks the front wheels and the parking brake blocks the rear wheels, unless stated otherwise by the OEM.

6.3.3. Maritime transport and port terminals

- The IMO's new SOLAS Regulation, applicable as of 1st January 2016, requires vehicle carriers to be provided with two portable gas detectors. These shall be "capable of measuring concentrations of oxygen, flammable gases or vapours, hydrogen sulphide and carbon monoxide prior to entry into enclosed spaces." (SOLAS Regulation II-2/20-1).
- The International Maritime Organisation (IMO)'s 'Recommendation on safety measures for existing vehicle carriers carrying motor vehicles with compressed hydrogen or natural gas in their tanks for their own propulsion as cargo' notes that 'The shipper should provide a signed certificate or declaration that the vehicle fuel system, as offered for carriage, has been checked for leak-tightness and the vehicle is in proper condition for carriage prior to loading. In addition, the shipper is to mark, label or placard each vehicle, after it has been checked for leak-tightness and that it is in proper condition for carriage. During loading, the crew should check each vehicle for the shipper's markings.' (IMO Maritime Safety Committee's (MSC) Circular 1471).
- New build ships which had their keel laid after 1st January 2016 must have explosion proof equipment in cargo hold for hydrogen or natural gas if carrying such vehicles, as per the IMO Maritime Safety Committee's Resolution MSC.365(93).

6.4. Compounds

- Never leave the ignition key in as the car might move on its own in some cases. If it doesn't move, the ignition key can nevertheless cause the discharge of the battery.
- There is an "engine brake" on EVs: wheels are blocked when the battery is switched off.
- Charging the vehicles before delivery to dealers depends on individual OEM requirements.
- If an OEM allows for charging at the compound, it is recommended not to charge under extreme weather conditions. Charging can happen outside of a building but it is recommended not to charge in a snowy environment unless snow is removed from the charging area. It is recommended not to charge in extreme hot and cold. It is also recommended to avoid parking the vehicle with near zero charge for more than 3 months or with a high charge for more than a month.
- It depends on the OEM whether they allow slow or fast charging of its vehicles at compounds.
- The kind of electric plugs used at terminals and the supply of the charging equipment depends on the OEM.
- Vehicles should be left in Park mode. Always ensure this mode is engaged as even a slight press on the accelerator pedal can cause the vehicle to move quickly.
- Vehicles are silent so there is no engine sound to indicate that it is working.
- If a vehicle is equipped with a start button, all functions are activated when the button is pressed. If the vehicle is equipped with a key, some functions are active when the key is in. When the key is turned on, all functions are active.

6.5. PDI centres

- As some vehicles have no engine noise, in some workshops artificial noise is used so that personnel can hear vehicles approaching. This is, however, not yet general practice.
- There is European legislation that requires the mandatory use of “Acoustic Vehicle Alerting Systems” (AVAS) for all new electric and hybrid electric vehicles. “Manufacturers shall install AVAS in all new hybrid electric and pure electric vehicles by 1st July 2021.”
- High-pressure washing can't be used in the workshops to clean the cars from outside.

6.6. State of Charge level and Hydrogen supply

- If the 12V or the high voltage battery of a car is drained or if the State of Charge (SOC) level is too low the car cannot be loaded for transport. It has first to be recharged to a certain level which depends on OEM requirements.
- As general guidance, a Lithium Ion battery loses around 5% of its charge each month when it's in storage.
- On the other hand, if the SOC is too high, the car can't be kept in storage for a long time.
- In the case of Hydrogen Fuel Cell it is very unlikely that the vehicle runs out of fuel. The manufacturer has to be contacted in this case.

6.7. Non-starters / Towing

- For the towing of AFVs, please refer to the individual OEM's instructions.
- Connect the car with a 12V booster. This will in many cases allow engaging in “tow” mode.
- It is not possible to tow some models which have a key card because the wheels are blocked. These models have to be boosted and transported to the closest workshop to change the 12V battery. If any such “immobilisation” occurs, the vehicle cannot be towed.
- For towing, a towing bar must be used. It needs to be attached to the towing eye (if equipped) or to the lower suspension arms of the vehicle.

6.8. Training

- No common advice yet from the OEMs; some ask for trained personnel to handle and drive their AFVs, some don't. Some ask for a two-level training of the handling personnel: a first responder level which allows them to handle broken down and damaged cars and a more basic level.



ECG

BluePoint Brussels

Boulevard A. Reyers 80
1030 Brussels | Belgium

Tel: +32 2 706 82 80

info@ecgassociation.eu

www.ecgassociation.eu